

## 500V N-Channel MOSFET

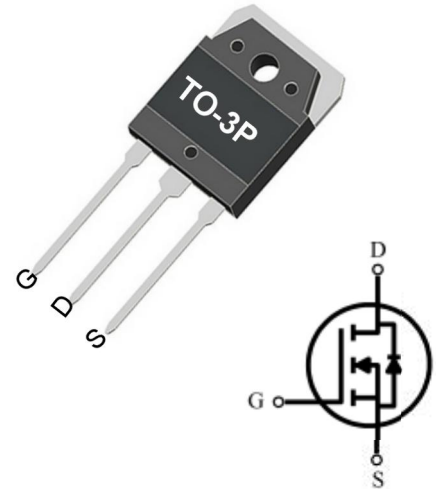
### Features

- $V_{DS}=500V$   $I_D=18A$   
 $R_{DS(ON)}=0.295\Omega(\text{max.})@V_{GS}=10V$
- Low On-Resistance
- Excellent  $CdV/dt$  effect decline
- Super Low Gate Charge
- 100% EAS Guaranteed
- Fast switching speed

### Applications

- Switch Mode Power Supply (SMPS)
- Uninterruptible Power Supply (UPS)
- Power Factor Correction (PFC)

### PIN DESCRIPTION



Part Number	Package	Marking	ROHS Status	Packing
SI18N50P	TO-3P	SI18N50P	ROHS	Box(Tube)

### Absolute Maximum Ratings ( $T_c=25^\circ\text{C}$ unless otherwise noted)

Symbol	Parameter	Value	Unit
$V_{DS}$	Drain-Source Voltage	500	V
$V_{GS}$	Gate-Source Voltage	$\pm 30$	V
$I_D$	Continuous Drain Current	18	A
$I_{DM}$	Pulsed Drain Current	76	A
$I_{AR}$	Avalanche Current	19	A
$E_{AS}$	Single Pulse Avalanche Energy	945	mJ
$T_J, T_{stg}$	Operating Junction and Storage Temperature Range	-55 to 150	$^\circ\text{C}$
$P_D$	Total Power Dissipation	$T_c=25^\circ\text{C}$ 239	W

### THERMAL RESISTANCE RATINGS

Symbol	Parameter	Value	Unit
$R_{\theta JA}$	Maximum Junction-to-Ambient	40	$^\circ\text{C}/\text{W}$
$R_{\theta JC}$	Maximum Junction-to-Case	0.52	

## Electrical Characteristics (T<sub>J</sub>=25°C unless otherwise Ratings )

Symbol	Parameter	Test Conditions	Min.	TYP.	Max.	Unit
<b>Static Characteristics</b>						
B <sub>V</sub> DSS	Drain-source breakdown voltage	V <sub>GS</sub> =0V, I <sub>DS</sub> = 250uA	500	-	-	V
V <sub>GS(th)</sub>	Gate threshold voltage	V <sub>DS</sub> =V <sub>GS</sub> , I <sub>DS</sub> =250uA	2	-	4	V
I <sub>DSS</sub>	Drain-Source Leakage Current	V <sub>DS</sub> =500V, V <sub>GS</sub> =0V	-	-	1	uA
		V <sub>DS</sub> =400V, V <sub>GS</sub> =0V, T <sub>c</sub> =125°C	-	-	10	uA
I <sub>GSS</sub>	Gate-source leakage current	V <sub>DS</sub> =0V, V <sub>GS</sub> =±30V	-	-	±100	nA
R <sub>DS(on)</sub>	Drain-source on-state resistance	V <sub>GS</sub> =10V, I <sub>D</sub> =10A	-	-	0.295	Ω
<b>Dynamic Characteristic</b>						
Q <sub>g</sub>	Total Gate Charge	V <sub>GS</sub> =10V, V <sub>DD</sub> =400V I <sub>D</sub> =20A	-	45.5	-	nC
Q <sub>gs</sub>	Gate-Source Charge		-	15.8	-	nC
Q <sub>gd</sub>	Gate-Drain Charge		-	21.6	-	nC
T <sub>d(on)</sub>	Turn-on delay time	I <sub>D</sub> =20A, V <sub>DD</sub> =250V, R <sub>G</sub> =25Ω	-	55	-	nS
T <sub>r</sub>	Rise time		-	165	-	nS
T <sub>d(off)</sub>	Turn-off delay time		-	95	-	nS
T <sub>f</sub>	Fall time		-	90	-	nS
C <sub>iss</sub>	Input Capacitance	V <sub>GS</sub> =0V, V <sub>DS</sub> =25V f=1.0MHz	-	2200	-	pF
C <sub>oss</sub>	Output Capacitance		-	330	-	pF
C <sub>rss</sub>	Reverse Transfer Capacitance		-	25	-	pF
<b>Source-Drain Diode</b>						
V <sub>SD</sub>	Diode Forward Voltage	V <sub>GS</sub> =0V, I <sub>SD</sub> =20A	-	-	1.4	V
I <sub>SM</sub>	Pulsed Source Current	V <sub>G</sub> =V <sub>D</sub> =0V, T <sub>C</sub> =25°C	-	-	76	A
I <sub>S</sub>	Continuous Source Current		-	-	19	A
T <sub>rr</sub>	Reverse Recovery Time	V <sub>GS</sub> =0V, I <sub>S</sub> =20A, diF/dt=100A/μs	-	500	-	ns
Q <sub>rr</sub>	Reverse Recovery Charge		-	5.4	-	uC

### Notes:

1. Repetitive Rating: Pulse width limited by maximum junction temperature.
2. Pulse Test: Pulse width ≤ 300μs, Duty Cycle ≤ 2% .

## Typical Performance Characteristics

Figure 1. On-Region Characteristics

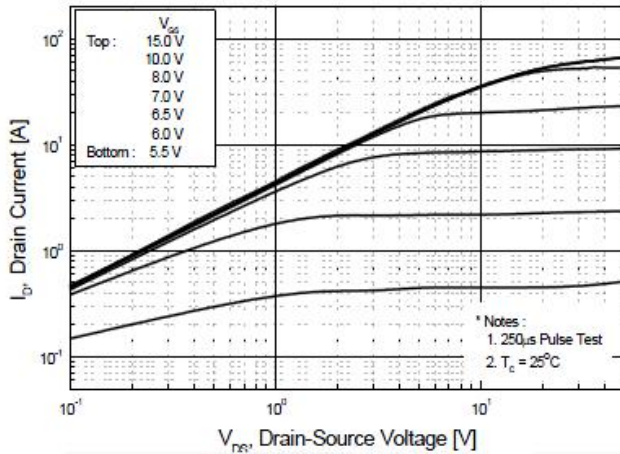


Figure 2. Transfer Characteristics

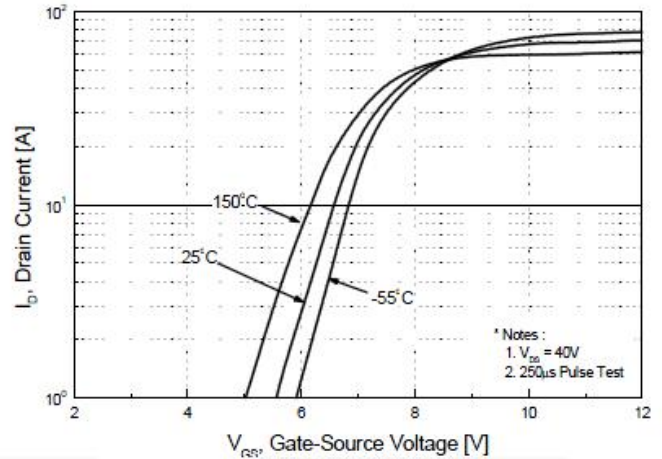


Figure 3. On-Resistance Variation vs. Drain Current and Gate Voltage

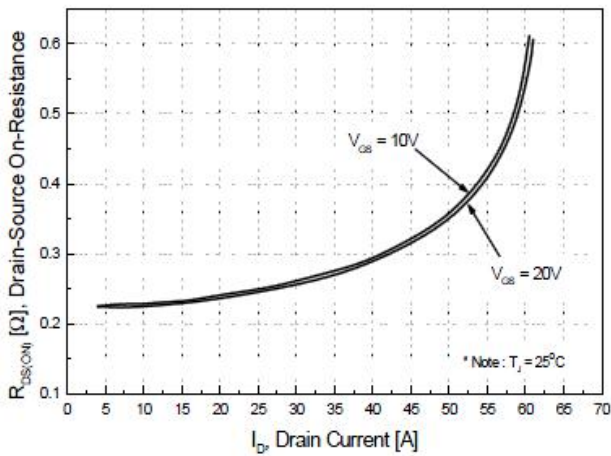


Figure 4. Body Diode Forward Voltage Variation vs. Source Current and Temperature

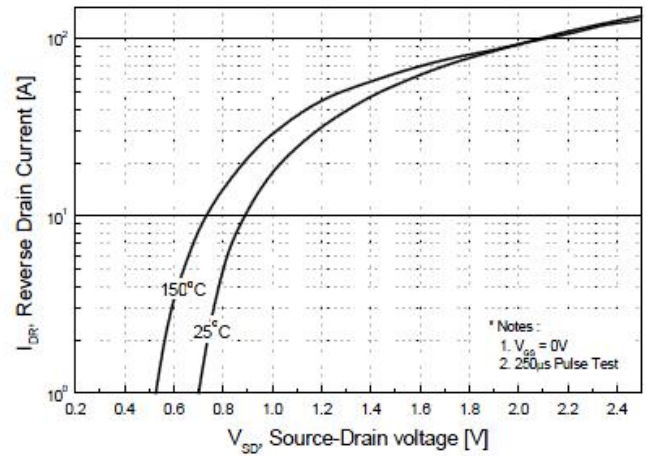


Figure 5. Capacitance Characteristics

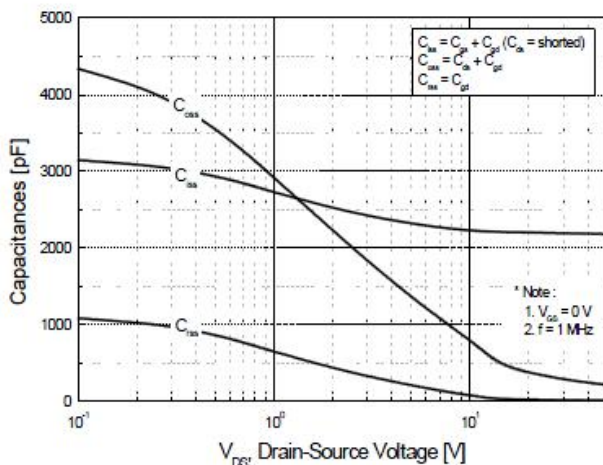
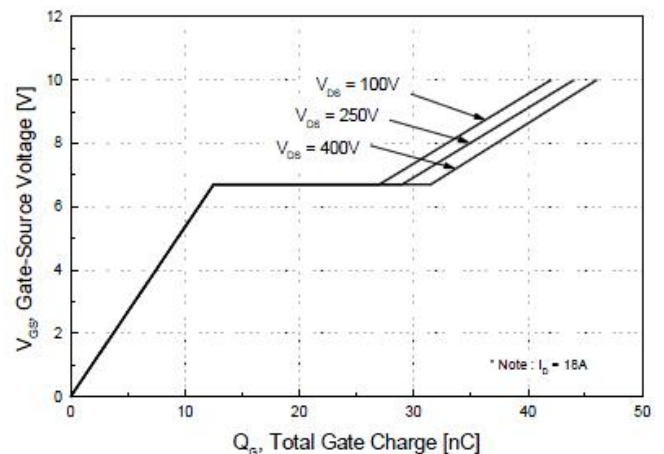
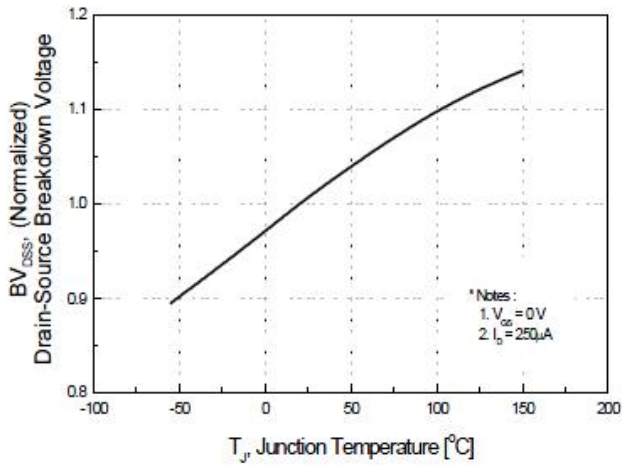


Figure 6. Gate Charge Characteristics

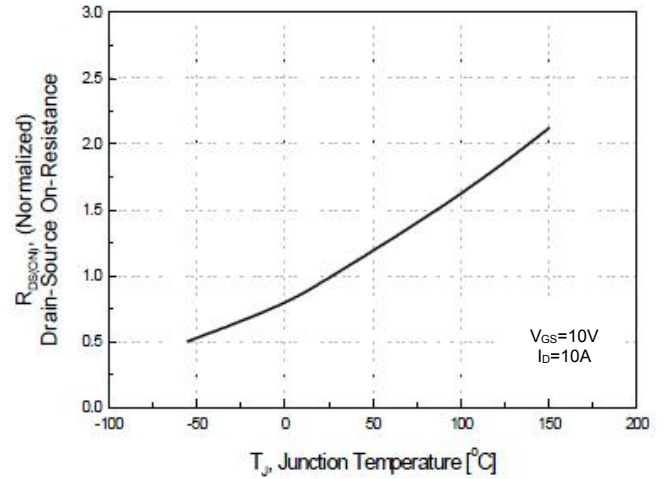


## Typical Performance Characteristics (Cont.)

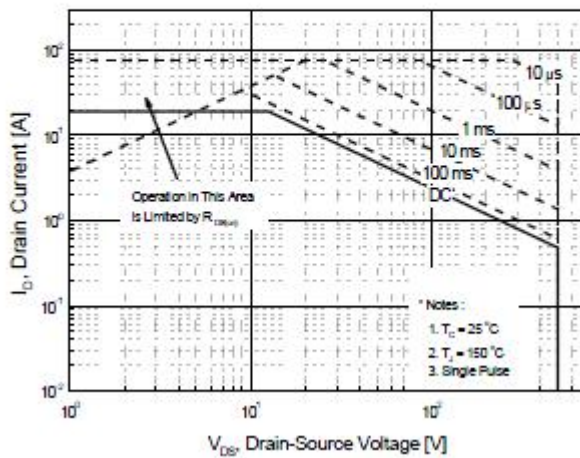
**Figure 7. Breakdown Voltage Variation vs. Temperature**



**Figure 8. On-Resistance Variation vs. Temperature**

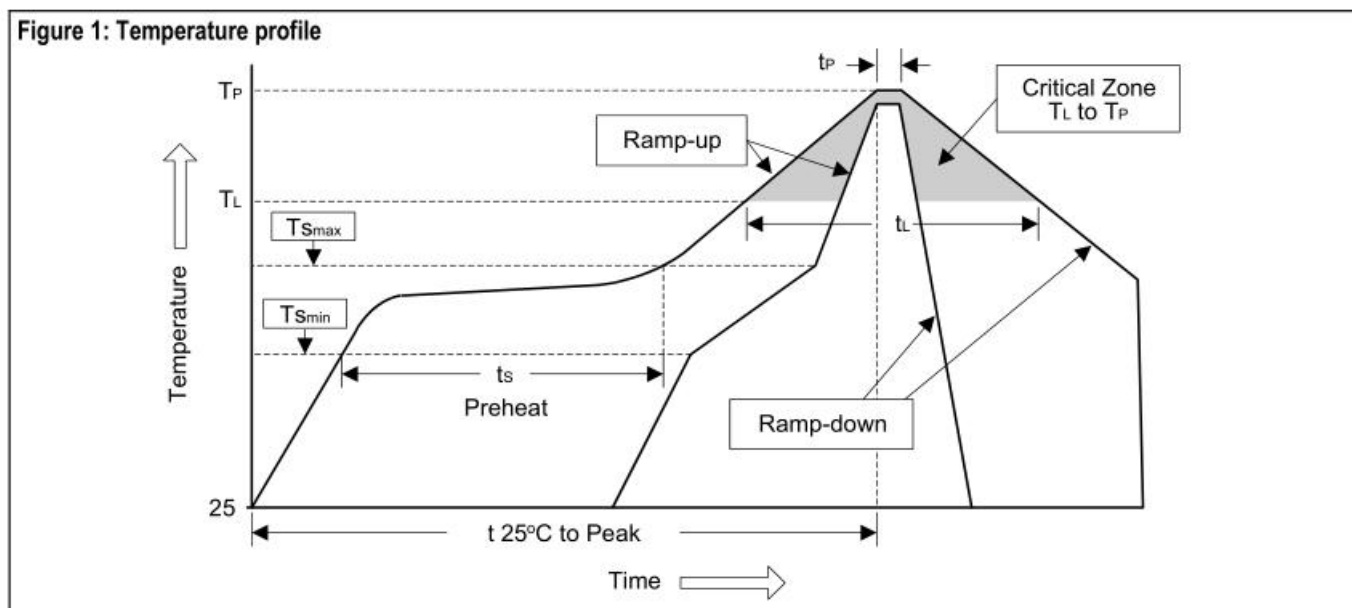


**Figure 9. Maximum Safe Operating Area**



## Soldering Methods for Products

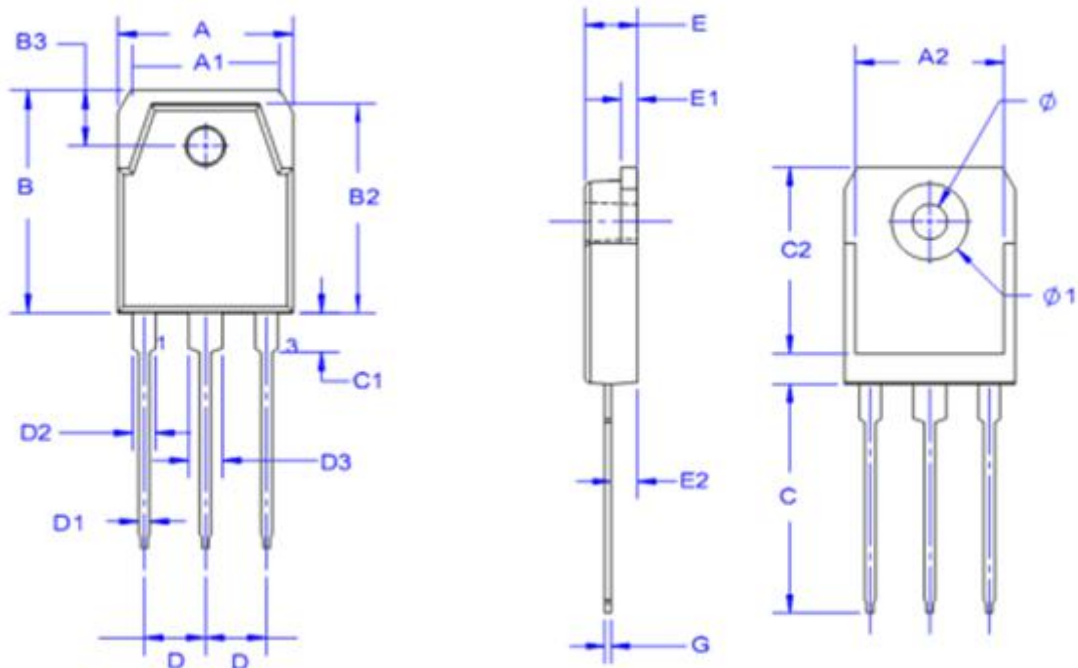
Profile Feature	Sn-Pb Eutectic Assembly	Pb-Free Assembly
Average ramp-up rate(TL to TP)	<3°C/sec	<3°C/sec
Preheat	-	-
-Temperature Min(Ts min)	100°C	150°C
-Temperature Max(Ts max)	150°C	200°C
-Time(min to max)(ts)	60 to 120 sec	60 to 180 sec
Ts max to TL		
- ramp-up rate	<3°C/sec	<3°C/sec
Time maintained above:		
-Temperature(TL)	183°C	217°C
-Time(TL)	60 to 150 sec	60 to 150 sec
Peak Temperature(TP)	240°C+0/-5°C	250°C+0/-5°C
Time within 5°C of actual Peak Temperature	10 to 30 sec	20 to 40 sec
Ramp-down Rate	<6°C/sec	<6°C/sec
Time 25 °C to Peak Temperature	<6 minutes	<8 minutes



- Note :**
- 1.Storage environment: Temperature=10°C to 35@Humidity=45%±15%
  - 2.Reflow soldering of surface-mount devices
  - 3.Flow(wave) soldering(solder dipping)

Products	Peak Temperature	Dipping Time
Pb devices	245°C±5°C	5sec±1sec
Pb-free devices	250°C+0/-5°C	5sec±1sec

## Package Outline



unit: mm

Symbol	Min	Max	Symbol	Min	Max
<b>A</b>	15.40	15.80	<b>D</b>	5.45Typ	
<b>A1</b>	13.40	13.80	<b>D1</b>	0.8	1.2
<b>A2</b>	13.4	13.8	<b>D2</b>	1.8	2.2
<b>B</b>	19.70	20.10	<b>D3</b>	2.8	3.2
<b>B1</b>	13.50	13.90	<b>E</b>	4.60	5.00
<b>B2</b>	12.56	13.06	<b>E1</b>	1.45	1.65
<b>B3</b>	3.40	3.80	<b>E2</b>	1.20	1.60
<b>C</b>	19.70	20.30	<b>G</b>	0.55	0.75
<b>C1</b>	3.30	3.70	<b>θ</b>	3.0	3.4
<b>C2</b>	16.20	16.80	<b>Ø1</b>	3.8	7.2

## ■ Important Notice

Si-Trend reserves the right to change all product 、 product specifications and data without prior notice ; Our customer Please confirm to place an order confirmation before make the integrity of information complete and up-to-date ◦

Any semiconductor under specific conditions are possible to certain failure or malfunction rate ; Customers are responsible in the use of Si-Trend products to system design and manufacturing in compliance with safety standards and adopting safety measures , To avoid the potential risk of failure may cause the personal safety and property loss ◦

Si-Trend Always refine on to provide more excellent products

## ■ Modify record

Date	Version	Description	Pagination
20170215	A.0	original	7