

30A 600V Fast Recovery Epitaxial Diode(FRED)

Features

VOLTAGE	600 V
CURRENT	30A

- Ultrafast Recovery Time
- Soft Recovery Characteristics
- Low Forward Voltage
- Low stored Charge
- Low Leakage Current
- Low Recovery Loss

PIN DESCRIPTION

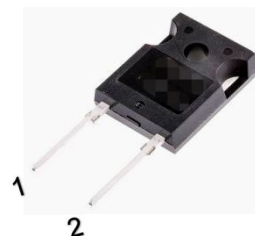

TO-247



Mechanical Data

- Case: TO-247
- Freewheeling, Snubber, Clamp
- Snubber Diode
- Switch Power Supplies
- Motor control
- Inverters Converters
- PFC

Package	Part No.	ROHS Status	Packing
TO-247	SI30U600H	Pb-Free	Box (Tube)

MAXIMUM RATINGS($T_A=25\text{ }^\circ\text{C}$ unless otherwise noted)

PARAMETER	SYMBOL	VALUE	UNITS
Maximum Recurrent Peak Reverse Voltage	V_{RRM}	600	V
Maximum RMS voltage	V_{RMS}	420	V
Maximum DC blocking voltage	V_{DC}	600	V
Average Rectified Forward Current	$I_{F(AV)}$	30	A
Peak forward surge current, 8.3ms single half sine-wave superimposed on rated load	I_{FSM}	300	A
Operating Junction Temperature	T_J	-55 to150	$^\circ\text{C}$
Operating Junction and Storage Temperature Range	T_{STG}	-55 to150	$^\circ\text{C}$

ELECTRICAL CHARACTERISTICS ($T_A=25\text{ }^\circ\text{C}$ unless otherwise noted)

Symbol	Parameter	Test Conditions	Min	TYP	Max	Unit
Static Characteristics						
V_{BR}	Reverse Breakdown Voltage	$I_R=50\mu\text{A}$	600	-	-	V
V_F	Instantaneous forward voltage per diode	$I_F=30\text{A}, T_a=25\text{ }^\circ\text{C}$	-	1.9	2.5	V
		$I_F=15\text{A}, T_a=125\text{ }^\circ\text{C}$	-	1.35	2.0	V
I_R	Reverse current per diode	$V_R=600\text{V}, T_a=25\text{ }^\circ\text{C}$	-	-	2	μA
T_{rr}	Reverse Recovery Time	$I_F=0.5\text{A}, I_R=1\text{A}, I_{rr}=0.25\text{A}$	-	26	35	ns
		$I_F=1\text{A}, V_R=30\text{V}, di/dt=-200\text{A}/\mu\text{s}$	-	24	-	ns

Remark:

- 1.Customer should obtain the latest version of datasheet before placing order, and verify the relevant information.
- 2.Cutting damage and chipping area can't beyond scribe line in given size range.
- 3.Testing system of T_{rr} could be different, customer might take secondary test to evaluate if necessary.
- 4.Customer might choose the bonding wire material and diameter according to actual situation, while no less than our recommendation.

Typical Operating Characteristics

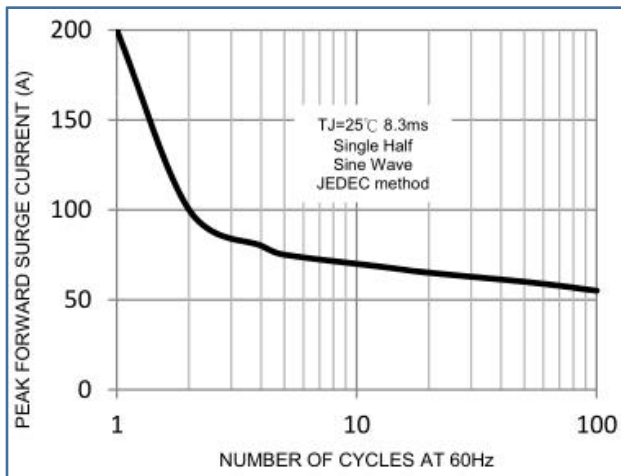

FIG.1-Maximum Non-Repetitive Forward Surge Current

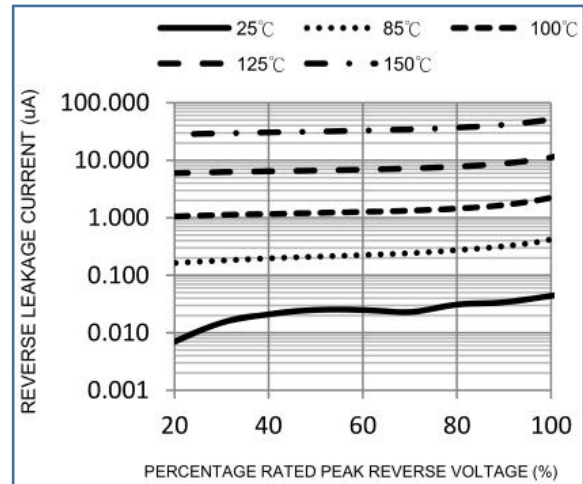

FIG.2-Typical Reverse Characteristics

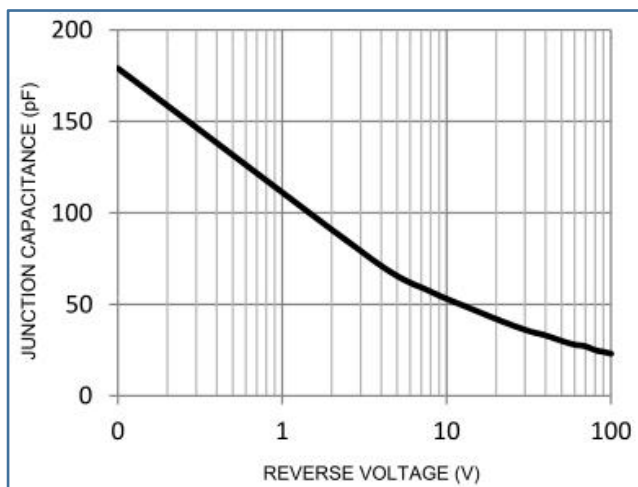

FIG.3 Typical Junction Capacitance

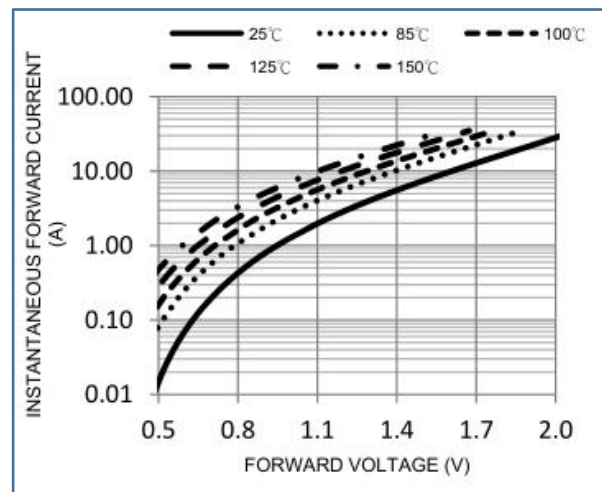
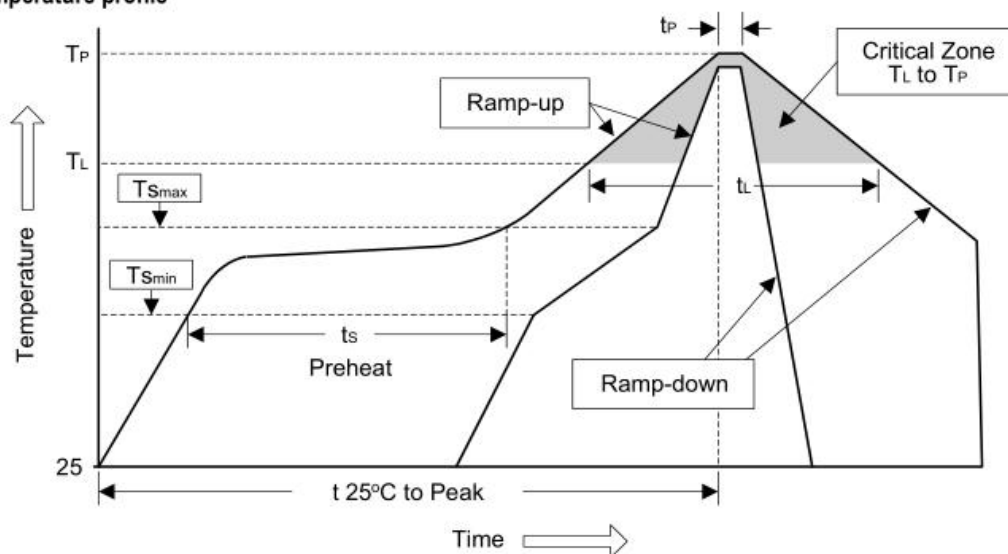

FIG.4 Typical Forward Characteristics

Soldering Methods for Products

Profile Feature	Sn-Pb Eutectic Assembly	Pb-Free Assembly
Average ramp-up rate(TL to TP)	<3°C/sec	<3°C/sec
Preheat		
-Temperature Min(Ts min)	100°C	150°C
-Temperature Max(Ts max)	150°C	200°C
-Time(min to max)(ts)	60 to 120 sec	60 to 180 sec
Ts max to TL		
- ramp-up rate	<3°C/sec	<3°C/sec
Time maintained above:		
-Temperature(TL)	183°C	217°C
-Time(t L)	60 to 150 sec	60 to 150 sec
Peak Temperature(T p)	240°C+0/-5°C	250°C+0/-5°C
Time within 5°C of actual Peak Temperature	10 to 30 sec	20 to 40 sec
Ramp-down Rate	<6°C/sec	<6°C/sec
Time 25 °C to Peak Temperature	<6 minutes	<8 minutes

Figure 1: Temperature profile



- Note :**
- 1.Storage environment: Temperature=10°C to 35@Humidity=45%±15%
 - 2.Reflow soldering of surface-mount devices
 - 3.Flow(wave) soldering(solder dipping)

Products	Peak Temperature	Dipping Time
Pb devices	245°C±5°C	5sec±1sec
Pb-free devices	250°C+0/-5°C	5sec±1sec

Package Outline

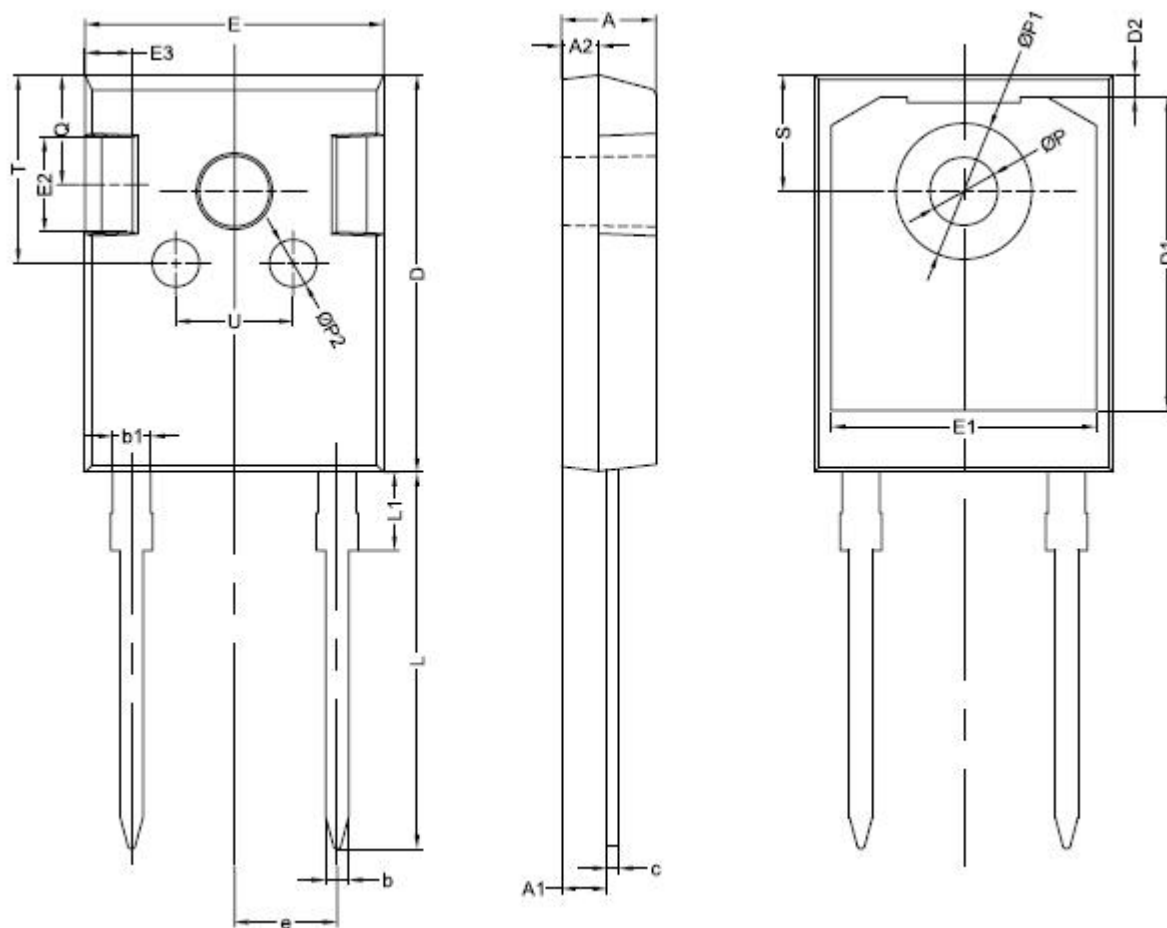

Millimeters/mm					
Symbol	Min	Max	Symbol	Min	Max
A	4.58	5.20	D2	1.17TYP.	
A1	2.21	2.61	E	15.60	16.0
A2	1.90	2.10	E1	14.02TYP.	
b	1.10	1.35	E2	5.00TYP.	
b1	2.00TYP.		E3	2.50TYP.	
c	0.55	0.75	e	5.44TYP.	
D	20.80	21.20	L	19.42	20.42
D1	16.58TYP.		L1	4.13TYP.	

■ Important Notice

Si-Trend reserves the right to change all product specifications and data without prior notice ; Our customer Please confirm to place an order confirmation before make the integrity of information complete and up-to-date ◦

Any semiconductor under specific conditions are possible to certain failure or malfunction rate ; Customers are responsible in the use of Si-Trend products to system design and manufacturing in compliance with safety standards and adopting safety measures , To avoid the potential risk of failure may cause the personal safety and property loss ◦

Si-Trend Always refine on to provide more excellent products

■ Modify record

Date	Version	Description	Pagination
20170626	A.0	original	6