

400V N-Channel POWER MOSFET

Features

- $V_{DSS}=400V$ $I_D=6A$
 $R_{DS(ON)}=1.0\Omega(\text{Max.})@V_{GS}=10V$
- Fast switching
- 100% avalanche tested
- Improved dv/dt capability
- Low ON Resistance

PIN DESCRIPTION

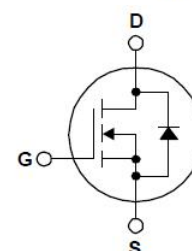
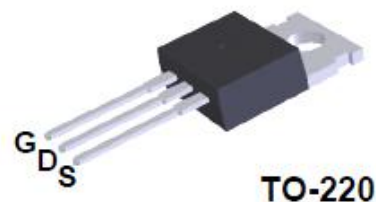

Applications

- Switch Mode Power Supply (SMPS)
- Uninterruptible Power Supply (UPS)
- Power Factor Correction (PFC)

Part Number	Package	Marking	ROHS Status	Packing
SI6N40B	TO-220	SI6N40B	Pb-Free	Box (Tube)

Absolute Maximum Ratings ($T_A=25^\circ\text{C}$ unless otherwise noted)

Symbol	Parameter	Typical	Unit
V_{DSS}	Drain-Source Voltage	400	V
V_{GSS}	Gate-Source Voltage	± 30	V
I_D	Continuous Drain Current	6	A
I_{DM}	Pulsed Drain Current	24	A
P_D	Power Dissipation ($T_C=25^\circ\text{C}$)	45	W
I_{AR}	Avalanche Current	4.8	A
E_{AS}	Single Pulse Avalanche Energy	115	mJ
E_{AR}	Repetitive Avalanche Energy	14	mJ
T_J, T_{stg}	Operating Junction and Storage Temperature Range	-55 to 150	$^\circ\text{C}$

Thermal Resistance

Parameter	Symbol	Value	Unit
Thermal resistance, Junction – Case.	R_{thJC}	2.8	$^\circ\text{C}/\text{W}$
Thermal resistance, Junction – Ambient.	R_{thJA}	60	

Electrical Characteristics ($T_A=25^\circ\text{C}$ unless otherwise noted)

Symbol	Parameter	Test Conditions	Min	TYP	Max	Unit
Static Characteristics						
BV_{DSS}	Drain-source breakdown voltage	$V_{GS}=0V, I_D=250\mu A$	400	-	-	V
I_{DSS}	Zero Gate Voltage Drain Current	$V_{DS}=400V, V_{GS}=0V$	-	-	1	μA
I_{GSS}	Gate-Source Leakage	$V_{GS}=\pm 30V$	-	-	± 100	nA
$V_{GS(th)}$	Gate-Source Threshold Voltage	$V_{DS}=V_{GS}, I_D=250\mu A$	3.0	-	4.0	V
$R_{DS(on)}$	Drain-Source On-Resistance	$V_{GS}=10V, I_D=3A$	-	-	1.0	Ω
Dynamic Characteristic						
C_{iss}	Input Capacitance	$V_{GS}=0V, V_{DS}=25V,$ $f=1.0MHz$	-	462	-	pF
C_{oss}	Output Capacitance		-	54.2	-	
C_{rss}	Reverse Transfer Capacitance		-	8.8	-	
Q_g	Gate Total Charge	$V_{DS}=320V, I_D=6A,$ $V_{GS}=10V,$	-	13.5	-	nC
Q_{gs}	Gate-Source charge		-	2	-	
Q_{gd}	Gate-Drain charge		-	6	-	
$t_{d(on)}$	Turn-on delay time	$V_{DD}=200V, I_D=6.0A,$ $R_G=25\Omega$	-	10	-	nS
t_r	Rise time		-	25	-	
$t_{d(off)}$	Turn-off delay time		-	40	-	
t_f	Fall time		-	52	-	
Drain-Source Body Diode Characteristics						
V_{SD}	Body Diode Forward Voltage	$V_{GS}=0V, I_{SD}=3A$	-	-	1.4	V
t_{rr}	Body Diode Reverse Recovery Time	$V_{GS}=0V, I_S=6A,$ $dI_F/dt = 100A/\mu s$	-	220	-	nS
Q_{rr}	Body Diode Reverse Recovery Charge		-	3	-	μC
I_S	Continuous Drain-Source Diode Forward Current		-	-	6	A
I_{SM}	Pulsed Drain-Source Diode Forward Current		-	-	24	A

Notes:

- 1.Repetitive Rating: Pulse width limited by maximum junction temperature
- 2.L=10mH, $V_{DD}=50V$, $R_G=25\Omega$, Starting $T_J=25^\circ$
- 3.Pulse Test: Pulse width $\leq 350\mu s$, Duty Cycle $\leq 1\%$

■ Switching Time Test Circuit and Wave forms

Figure A: Gate Charge Test Circuit and Waveform

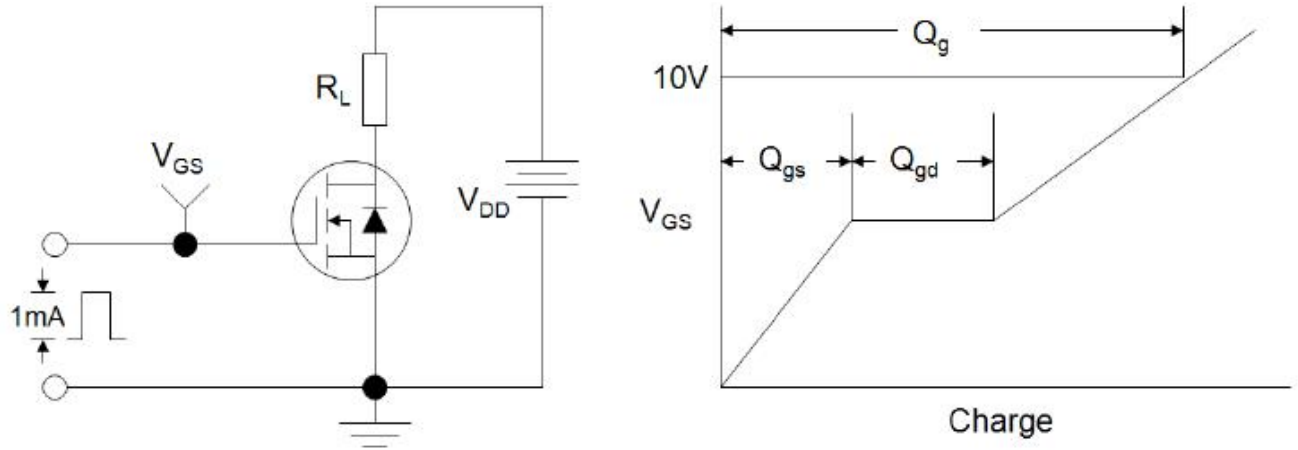

Figure B: Resistive Switching Test Circuit and Waveform

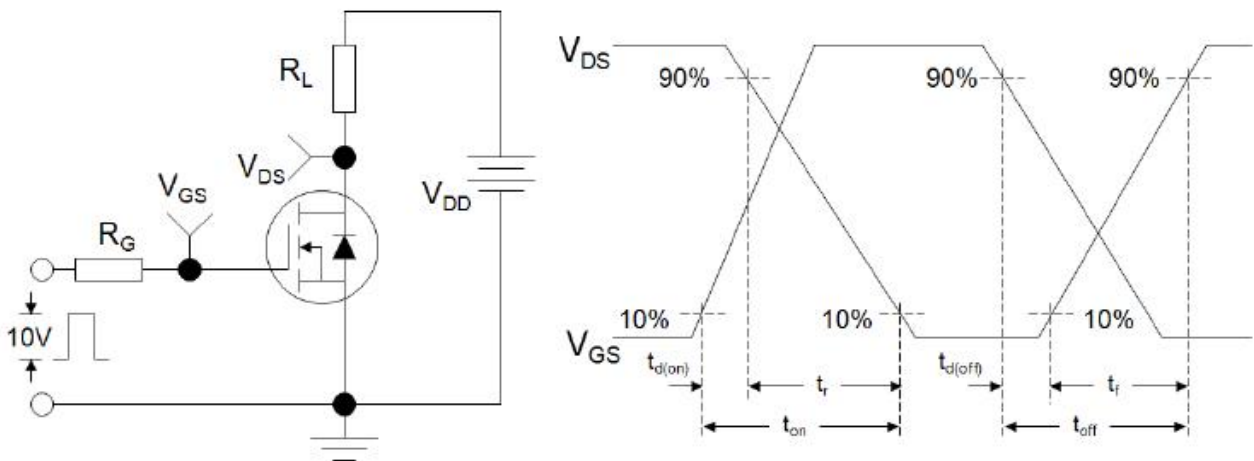
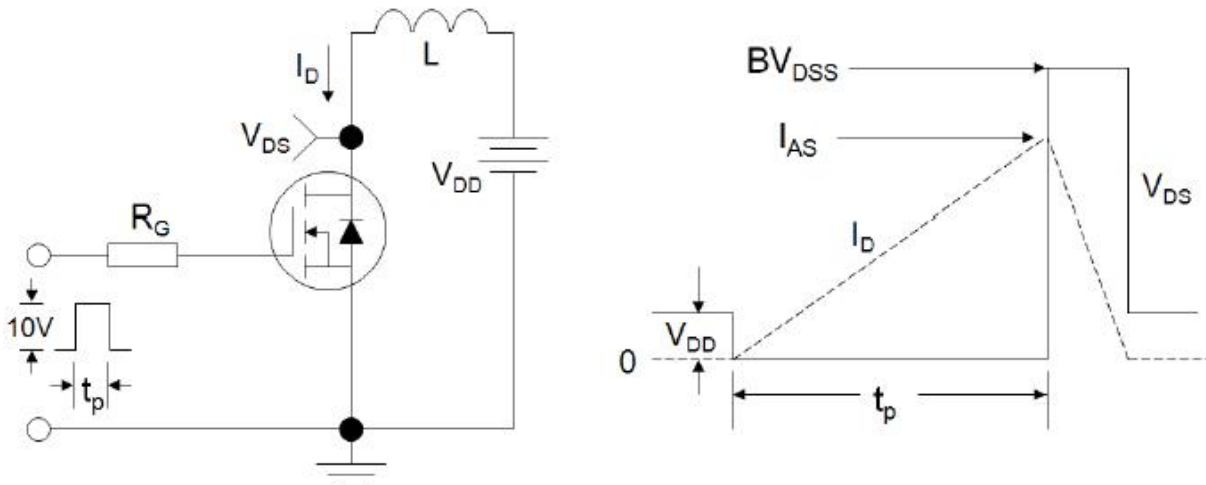

Figure C: Unclamped Inductive Switching Test Circuit and Waveform



Typical Performance Characteristics

Figure 1. Output Characteristics ($T_J = 25^\circ\text{C}$)

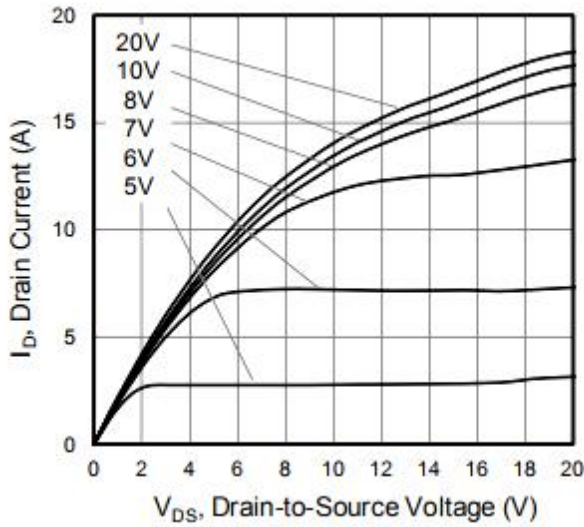

Figure 2. Body Diode Forward Voltage

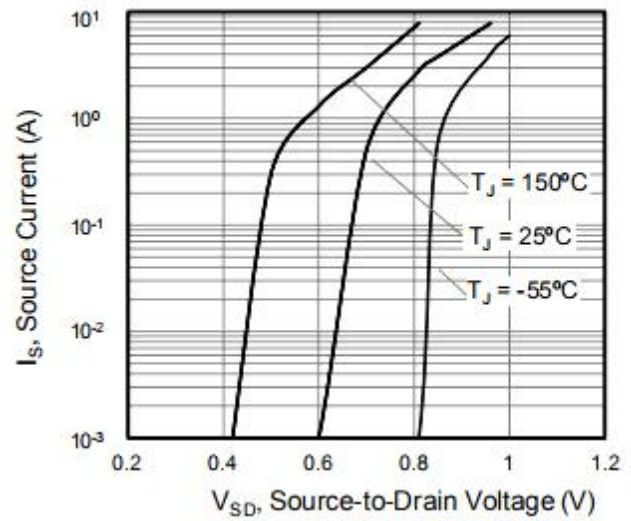

Figure 3. Drain Current vs. Temperature

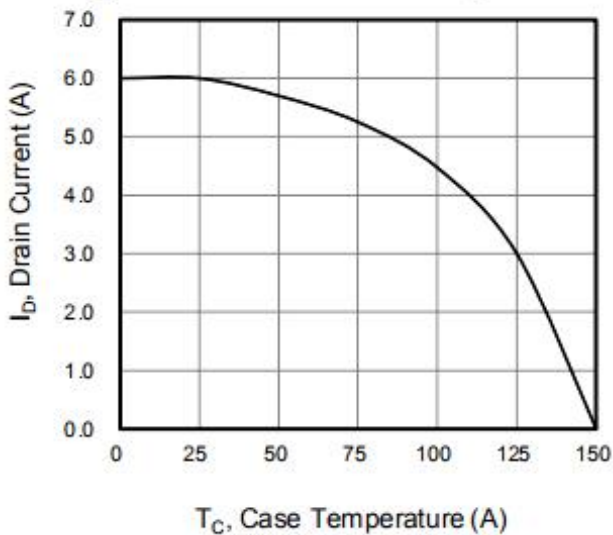

Figure 4. Power Dissipation vs. Temperature

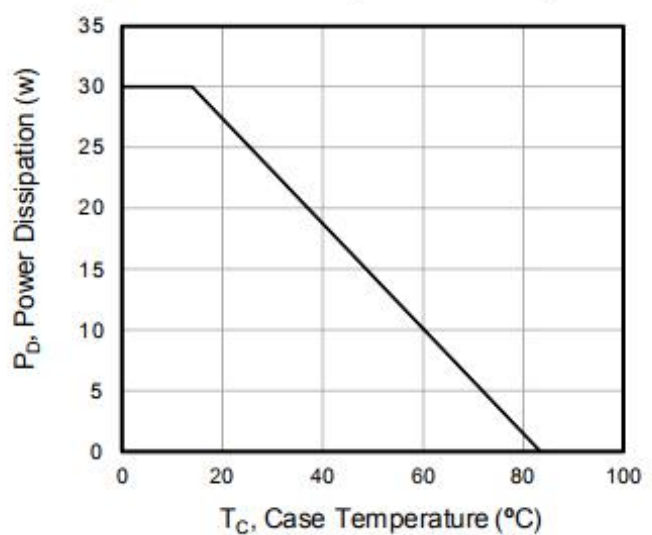

Figure 5. Transfer Characteristics

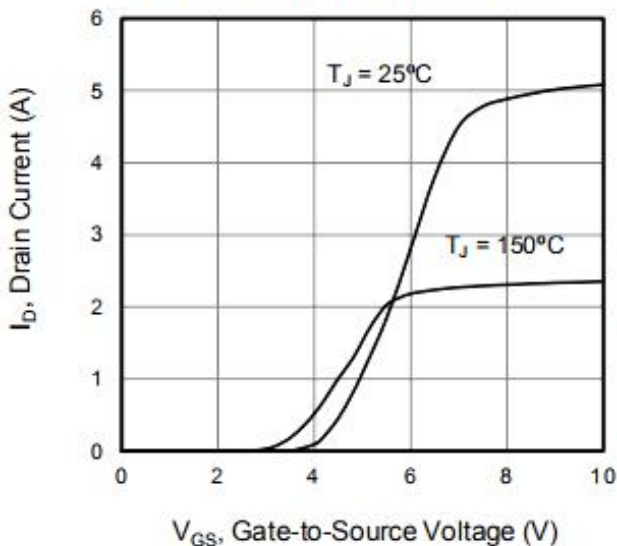
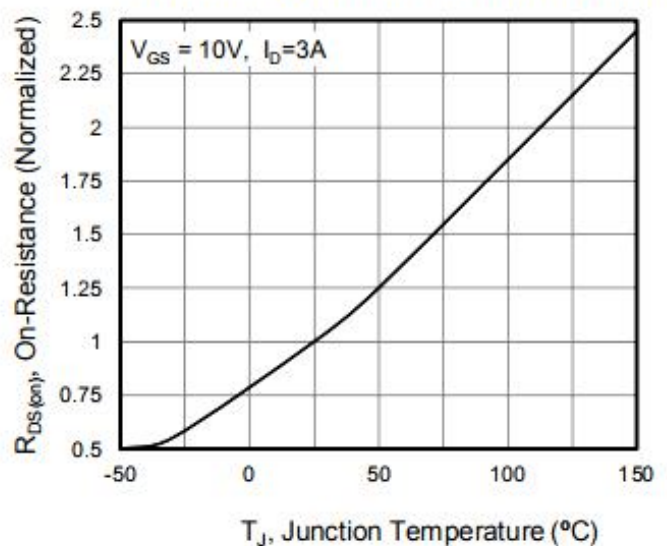
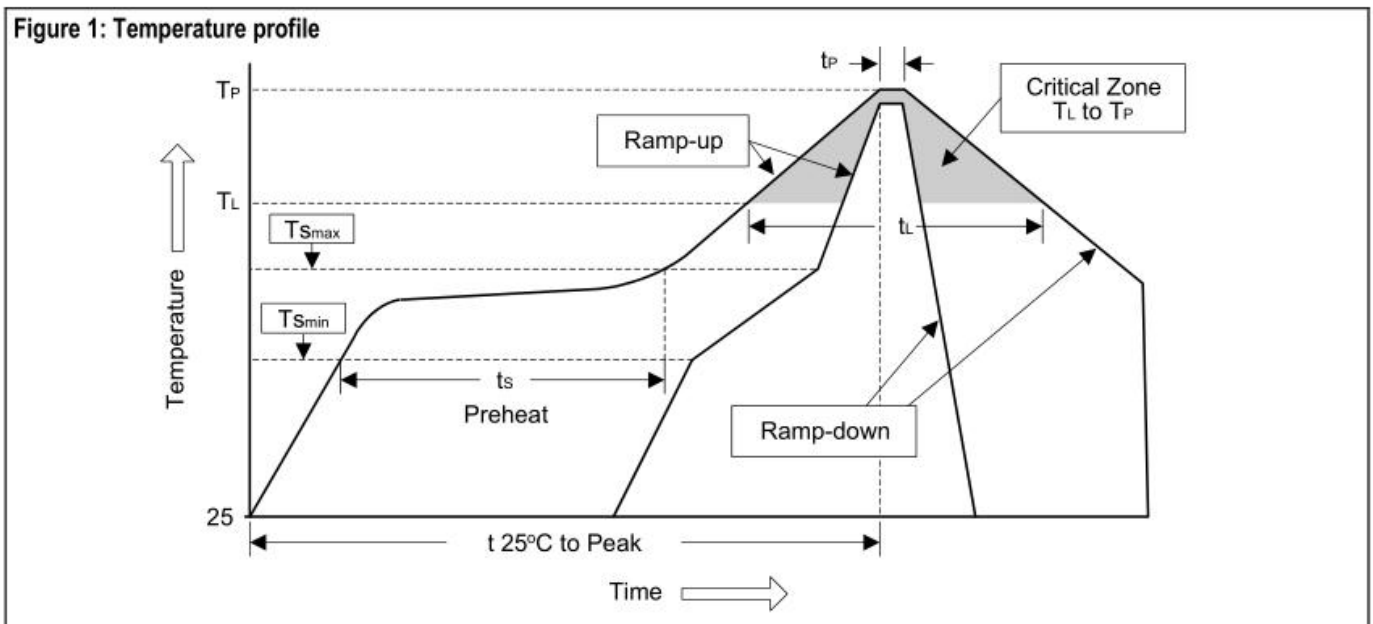

Figure 6. On-Resistance vs. Temperature



Soldering Methods for Products

Profile Feature	Sn-Pb Eutectic Assembly	Pb-Free Assembly
Average ramp-up rate(TL to TP)	<3°C/sec	<3°C/sec
Preheat -Temperature Min(Ts min) -Temperature Max(Ts max) -Time(min to max)(ts)	100°C 150°C 60 to 120 sec	150°C 200°C 60 to 180 sec
Tsmax to TL - ramp-up rate	<3°C/sec	<3°C/sec
Time maintained above: -Temperature(TL) -Time(tL)	183°C 60 to 150 sec	217°C 60 to 150 sec
Peak Temperature(Tp)	240°C+0/-5°C	250°C+0/-5°C
Time within 5°C of actual Peak Temperature	10 to 30 sec	20 to 40 sec
Ramp-down Rate	<6°C/sec	<6°C/sec
Time 25 °C to Peak Temperature	<6 minutes	<8 minutes



Note :1.Storage environment: Temperature=10°C to 35@Humidity=45%±15%

- 2.Reflow soldering of surface-mount devices
- 3.Flow(wave) soldering(solder dipping)

Products	Peak Temperature	Dipping Time
Pb devices	245°C±5°C	5sec±1sec
Pb-free devices	250°C+0/-5°C	5sec±1sec

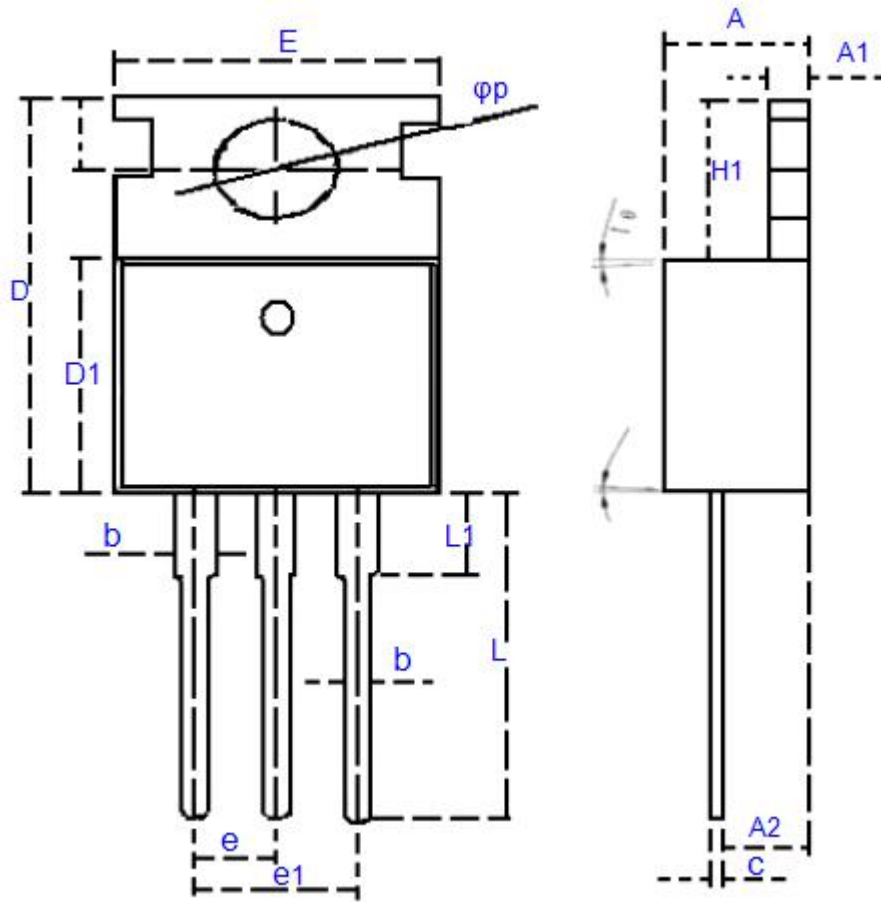
Package Outline

Millimeters					
Symbol	Min	Max	Symbol	Min	Max
A	4.2	4.8	E	9.6	10.5
A1	1.28	1.34	e	2.54 Typ.	
A2	2.2	2.6	e1	5.08	5.18
b	0.69	0.91	H1	6.1	7.0
b1	1.17	1.37	L	12.9	13.5
c	0.42	0.51	L1	2.9	3.7
D	15.1	16.3	ϕP	3.4	3.8
D1	9.0	9.5	$\theta 1$ (°)	1	5

■ Important Notice

Si-Trend reserves the right to change all product、 product specifications and data without prior notice ; Our customer Please confirm to place an order confirmation before make the integrity of information complete and up-to-date。

Any semiconductor under specific conditions are possible to certain failure or malfunction rate ; Customers are responsible in the use of Si-Trend products to system design and manufacturing in compliance with safety standards and adopting safety measures, To avoid the potential risk of failure may cause the personal safety and property loss。

Si-Trend Always refine on to provide more excellent products

■ Modify record

Date	Version	Description	Pagination
20170925	A.0	original	7