

## 400V N-Channel POWER MOSFET

### Features

- $V_{DSS}=400V$   $I_D=10A$
- $R_{DS(ON)}=0.55\Omega(\text{Max.})@V_{GS}=10V$
- Fast switching
- 100% avalanche tested
- Improved dv/dt capability
- Low ON Resistance

### Applications

- Switch Mode Power Supply (SMPS)
- Uninterruptible Power Supply (UPS)
- Power Factor Correction (PFC)

### PIN DESCRIPTION

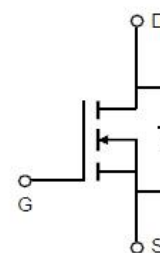
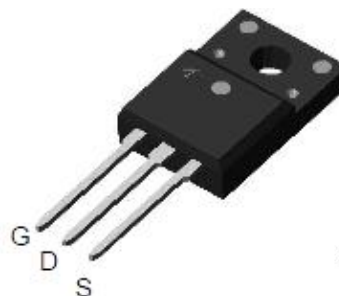

Part Number	Package	Marking	ROHS Status	Packing
SI10N40F	T0-220F	SI10N40F	Pb-Free	Box (Tube)

### Absolute Maximum Ratings ( $T_A=25^\circ\text{C}$ unless otherwise noted)

Symbol	Parameter	Typical	Unit
$V_{DSS}$	Drain-Source Voltage	400	V
$V_{GSS}$	Gate-Source Voltage	$\pm 30$	V
$I_D$	Continuous Drain Current	10	A
$I_{DM}$	Pulsed Drain Current	40	A
$P_D$	Power Dissipation ( $T_C=25^\circ\text{C}$ )	63	W
$I_{AR}$	Avalanche Current	4.4	A
$E_{AS}$	Single Pulse Avalanche Energy	96	mJ
$E_{AR}$	Repetitive Avalanche Energy	57	mJ
$T_J, T_{stg}$	Operating Junction and Storage Temperature Range	-55 to 150	$^\circ\text{C}$

### Thermal Resistance

Parameter	Symbol	Value	Unit
Thermal resistance, Junction – Case.	$R_{thJC}$	1.5	$^\circ\text{C}/\text{W}$
Thermal resistance, Junction – Ambient.	$R_{thJA}$	62.5	

**Electrical Characteristics** ( $T_A=25^\circ\text{C}$  unless otherwise noted)

Symbol	Parameter	Test Conditions	Min	TYP	Max	Unit
<b>Static Characteristics</b>						
$BV_{DSS}$	Drain-source breakdown voltage	$V_{GS}=0V, I_D=250\mu A$	400	-	-	V
$I_{DSS}$	Zero Gate Voltage Drain Current	$V_{DS}=400V, V_{GS}=0V$	-	-	1	$\mu A$
$I_{GSS}$	Gate-Source Leakage	$V_{GS}=\pm 30V$	-	-	$\pm 100$	nA
$V_{GS(th)}$	Gate-Source Threshold Voltage	$V_{DS}=V_{GS}, I_D=250\mu A$	3.0	-	4.0	V
$R_{DS(on)}$	Drain-Source On-Resistance	$V_{GS}=10V, I_D=5A$	-	-	0.55	$\Omega$
<b>Dynamic Characteristic</b>						
$C_{iss}$	Input Capacitance	$V_{GS}=0V, V_{DS}=25V,$ $f=1.0\text{MHz}$	-	1050	-	pF
$C_{oss}$	Output Capacitance		-	112	-	
$C_{rss}$	Reverse Transfer Capacitance		-	8	-	
$Q_g$	Gate Total Charge	$V_{DS}=320V, I_D=10A,$ $V_{GS}=10V,$	-	28	-	nC
$Q_{gs}$	Gate-Source charge		-	9	-	
$Q_{gd}$	Gate-Drain charge		-	7	-	
$t_{d(on)}$	Turn-on delay time	$V_{DD}=200V, I_D=10A,$ $R_G=25\Omega$	-	39	-	nS
$t_r$	Rise time		-	20	-	
$t_{d(off)}$	Turn-off delay time		-	138	-	
$t_f$	Fall time		-	34	-	
<b>Drain-Source Body Diode Characteristics</b>						
$V_{SD}$	Body Diode Forward Voltage	$V_{GS}=0V, I_{SD}=5A$	-	-	1.4	V
$t_{rr}$	Body Diode Reverse Recovery Time	$V_{GS}=0V, I_S=10A,$ $dI_F/dt=100A/\mu s$	-	249	-	nS
$Q_{rr}$	Body Diode Reverse Recovery Charge		-	1.87	-	$\mu C$
$I_S$	Continuous Drain-Source Diode Forward Current		-	-	10	A
$I_{SM}$	Pulsed Drain-Source Diode Forward Current		-	-	40	A

**Notes:**

- 1.Repetitive Rating: Pulse width limited by maximum junction temperature
- 2.L=10mH,  $V_{DD}=50V$ ,  $R_G=25\Omega$ , Starting  $T_J=25^\circ$
- 3.Pulse Test: Pulse width  $\leq 350\mu s$ , Duty Cycle  $\leq 1\%$

## ■ Switching Time Test Circuit and Wave forms

Figure A: Gate Charge Test Circuit and Waveform

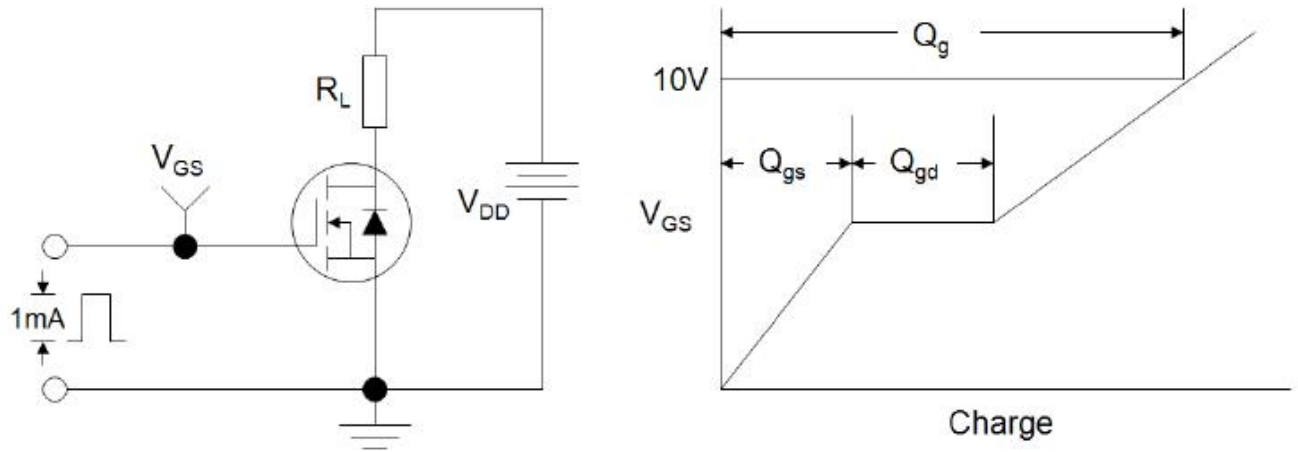

Figure B: Resistive Switching Test Circuit and Waveform

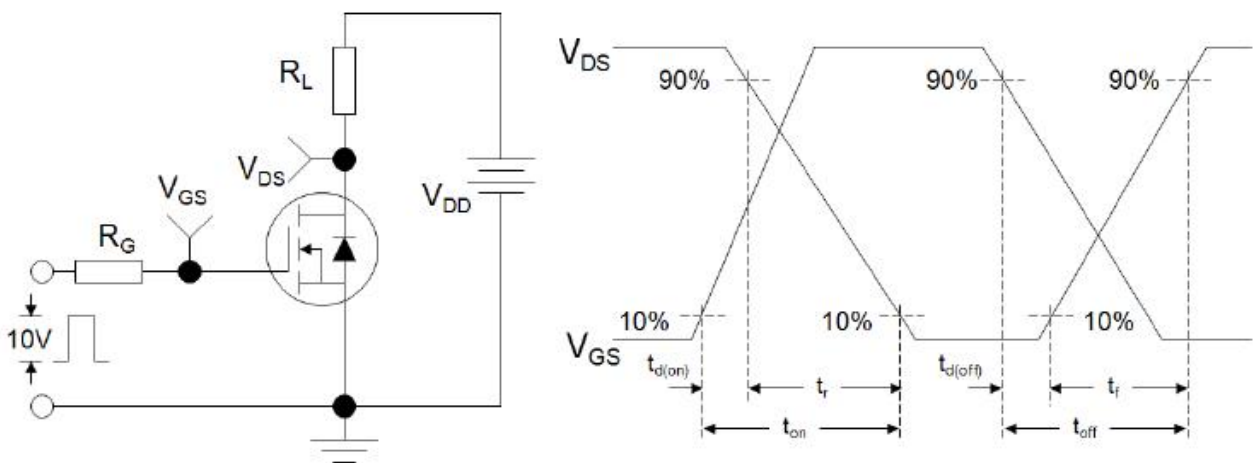
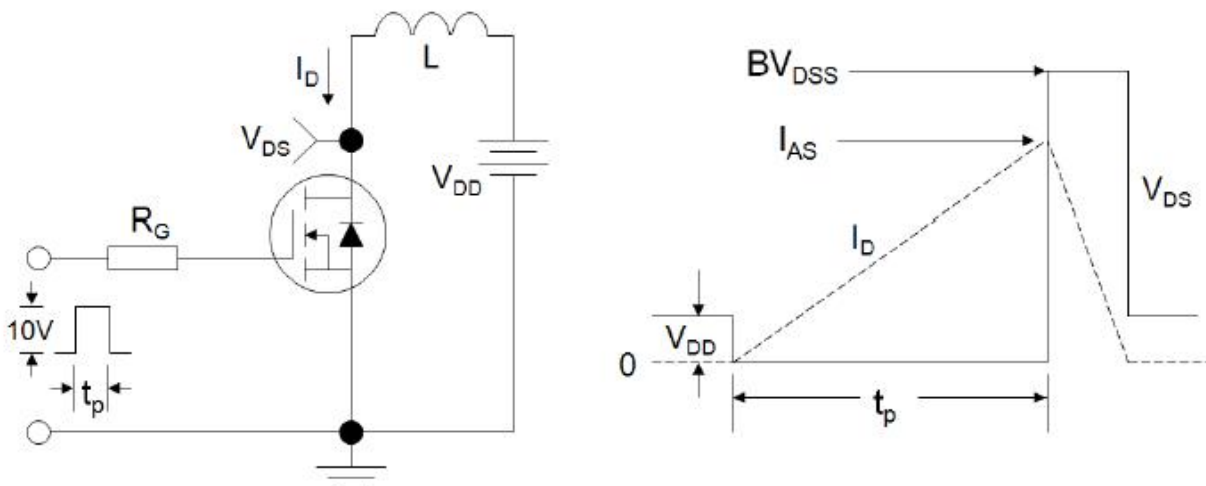
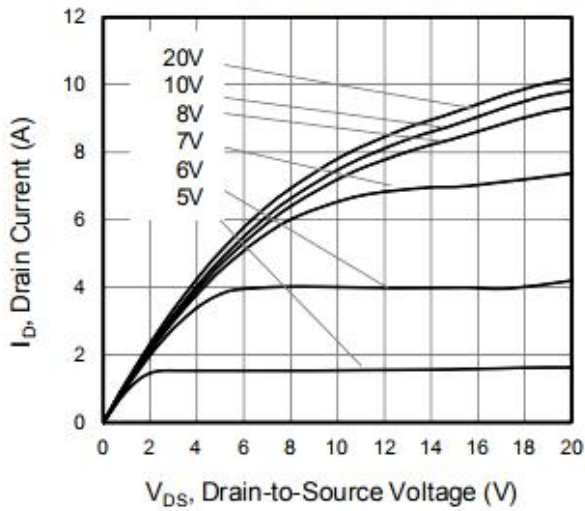
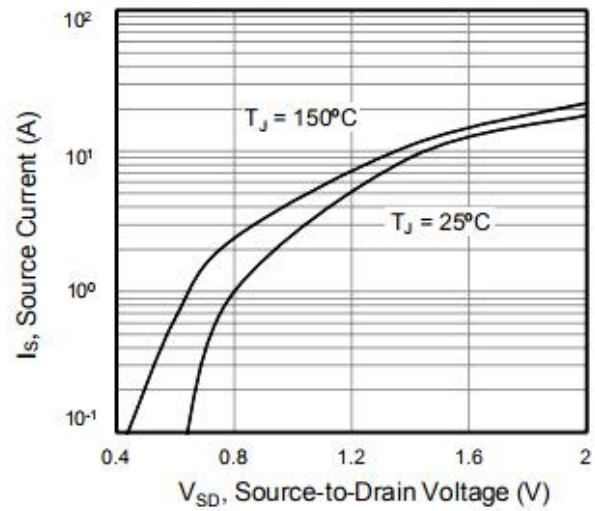
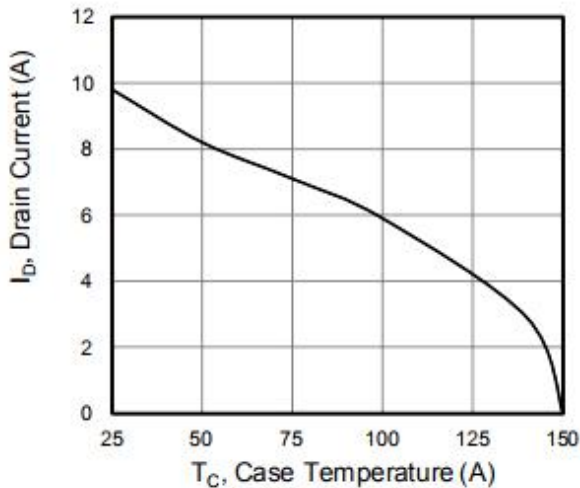
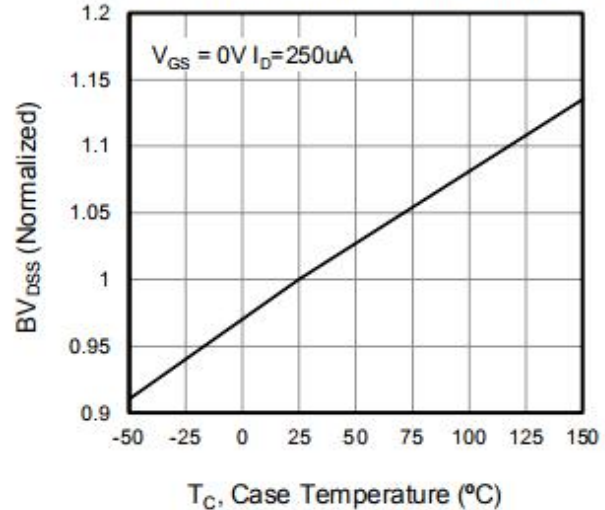
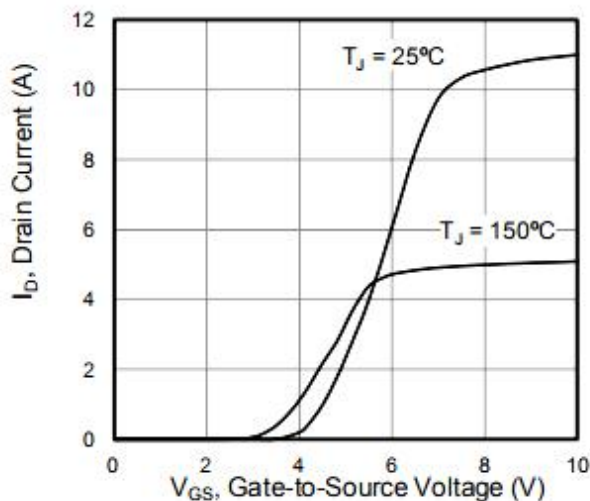
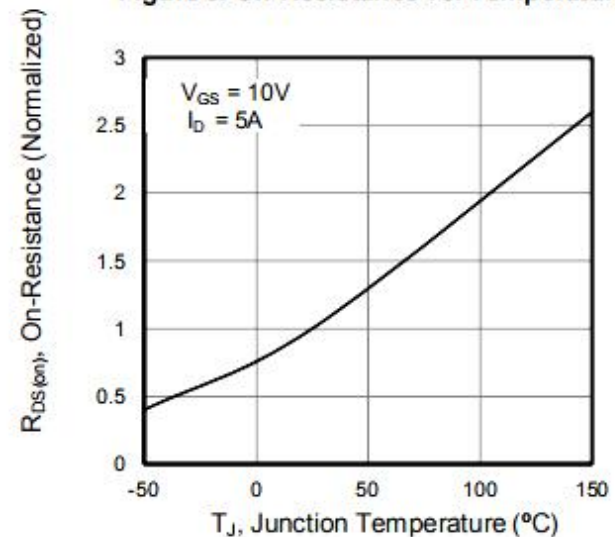

Figure C: Unclamped Inductive Switching Test Circuit and Waveform



## Typical Performance Characteristics

**Figure 1. Output Characteristics ( $T_J = 25^\circ\text{C}$ )**

**Figure 2. Body Diode Forward Voltage**

**Figure 3. Drain Current vs. Temperature**

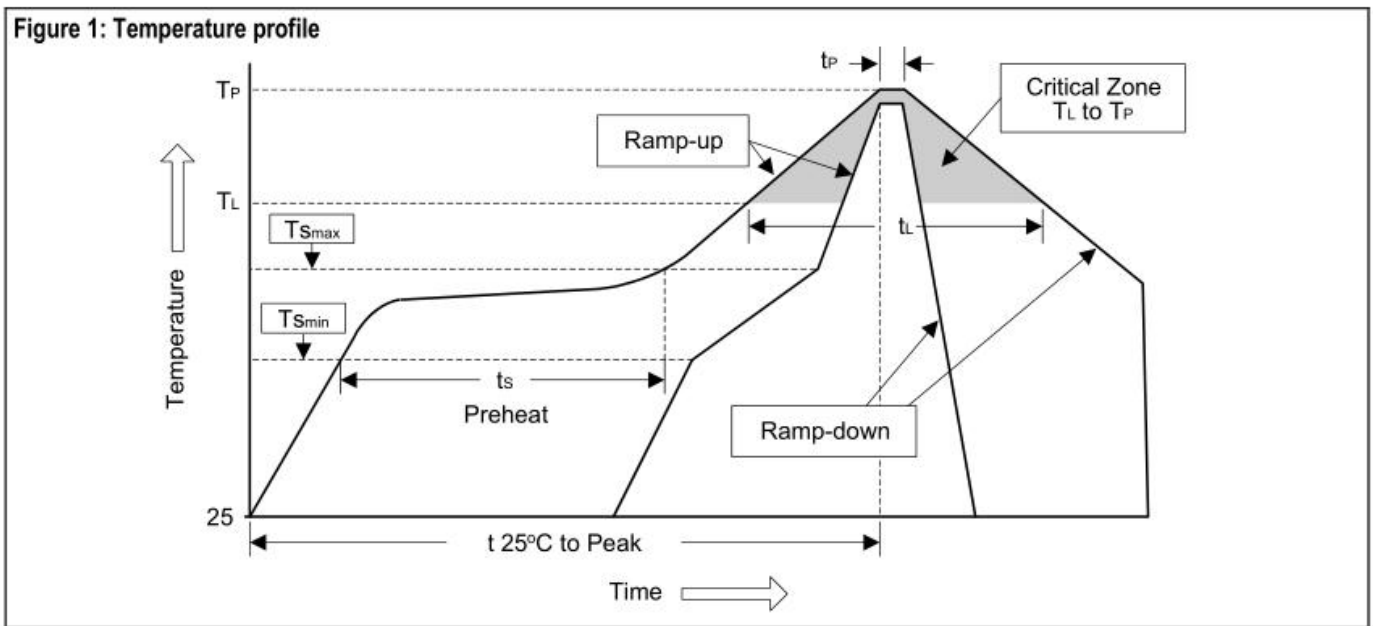
**Figure 4.  $BV_{DSS}$  Variation vs. Temperature**

**Figure 5. Transfer Characteristics**

**Figure 6. On-Resistance vs. Temperature**

**Soldering Methods for Products**

Profile Feature	Sn-Pb Eutectic Assembly	Pb-Free Assembly
Average ramp-up rate(TL to TP)	<3°C/sec	<3°C/sec
Preheat		
-Temperature Min(Ts min)	100°C	150°C
-Temperature Max(Ts max)	150°C	200°C
-Time(min to max)(ts)	60 to 120 sec	60 to 180 sec
Tsmax to TL		
- ramp-up rate	<3°C/sec	<3°C/sec
Time maintained above:		
-Temperature(TL)	183°C	217°C
-Time(tL)	60 to 150 sec	60 to 150 sec
Peak Temperature(Tp)	240°C+0/-5°C	250°C+0/-5°C
Time within 5°C of actual Peak Temperature	10 to 30 sec	20 to 40 sec
Ramp-down Rate	<6°C/sec	<6°C/sec
Time 25 °C to Peak Temperature	<6 minutes	<8 minutes



**Note :**1.Storage environment: Temperature=10°C to 35@Humidity=45%±15%

- 2.Reflow soldering of surface-mount devices
- 3.Flow(wave) soldering(solder dipping)

Products	Peak Temperature	Dipping Time
Pb devices	245°C±5°C	5sec±1sec
Pb-free devices	250°C+0/-5°C	5sec±1sec

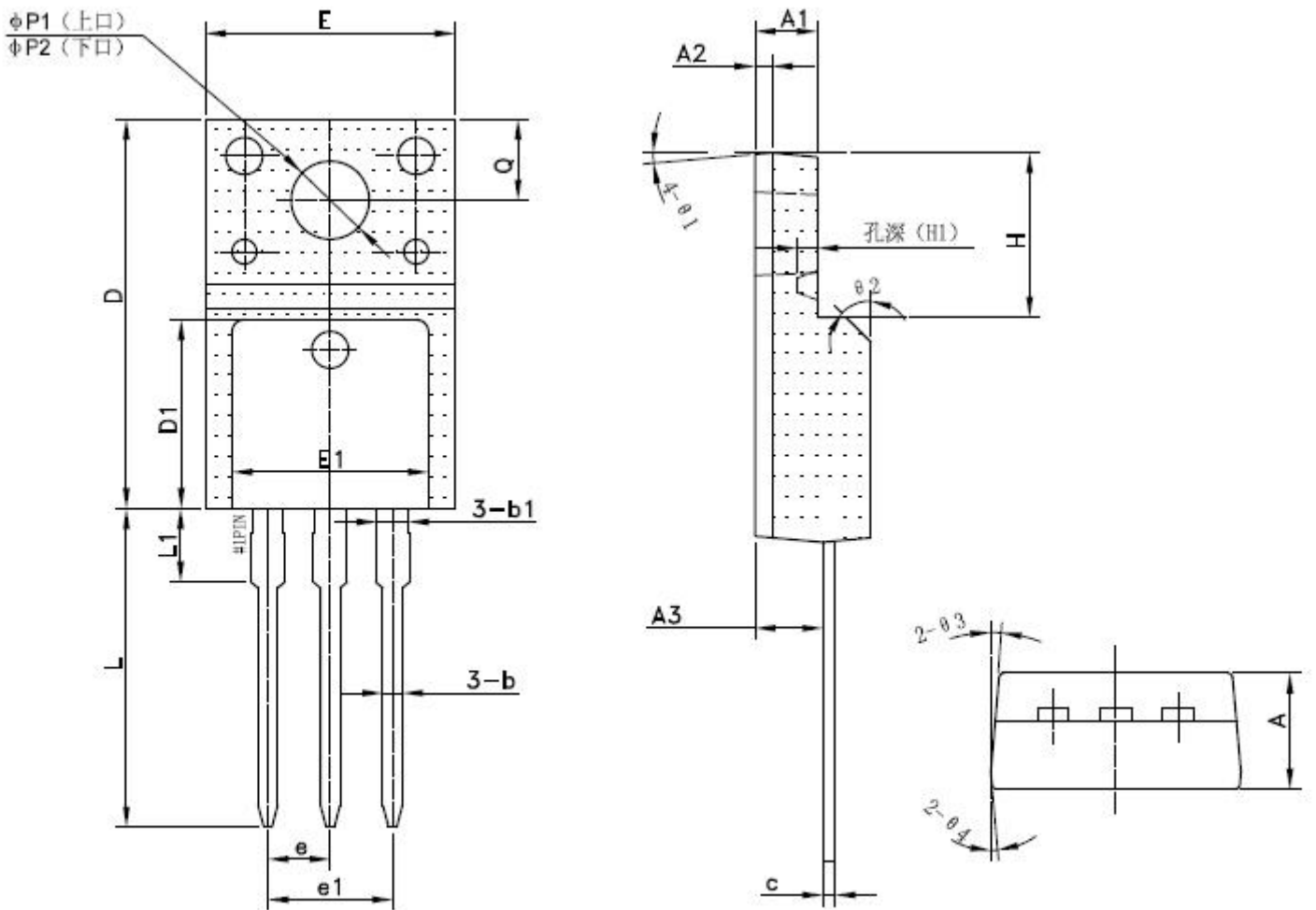
**Package Outline**

Millimeter(mm)					
Symbol	Min	Max	Symbol	Min	Max
A	4.50	4.90	E	9.96	10.36
A1	2.44	2.64	E1	8.00TYP	
A2	0.60	0.80	e	2.54TYP	
A3	2.56	2.96	e1	5.08TYP	
b	0.70	0.95	H	6.50	6.90
b1	1.28TYP		L	12.48	13.20
c	0.45	0.65	L1	2.93TYP	
D	15.67	16.07	P1	2.98	3.38
D1	7.70TYP		P2	3.20.	3.60

**■ Important Notice**

Si-Trend reserves the right to change all product、 product specifications and data without prior notice ; Our customer Please confirm to place an order confirmation before make the integrity of information complete and up-to-date。

Any semiconductor under specific conditions are possible to certain failure or malfunction rate ; Customers are responsible in the use of Si-Trend products to system design and manufacturing in compliance with safety standards and adopting safety measures, To avoid the potential risk of failure may cause the personal safety and property loss。

Si-Trend Always refine on to provide more excellent products

**■ Modify record**

Date	Version	Description	Pagination
20170825	A.0	original	7